

Mars Manned Mission

A conceptual Design

A concept based in the ISS Architecture

Version 1

April 2009

Miguel Cooper

Space_cooper@hotmail.com

Phone: 529211562326

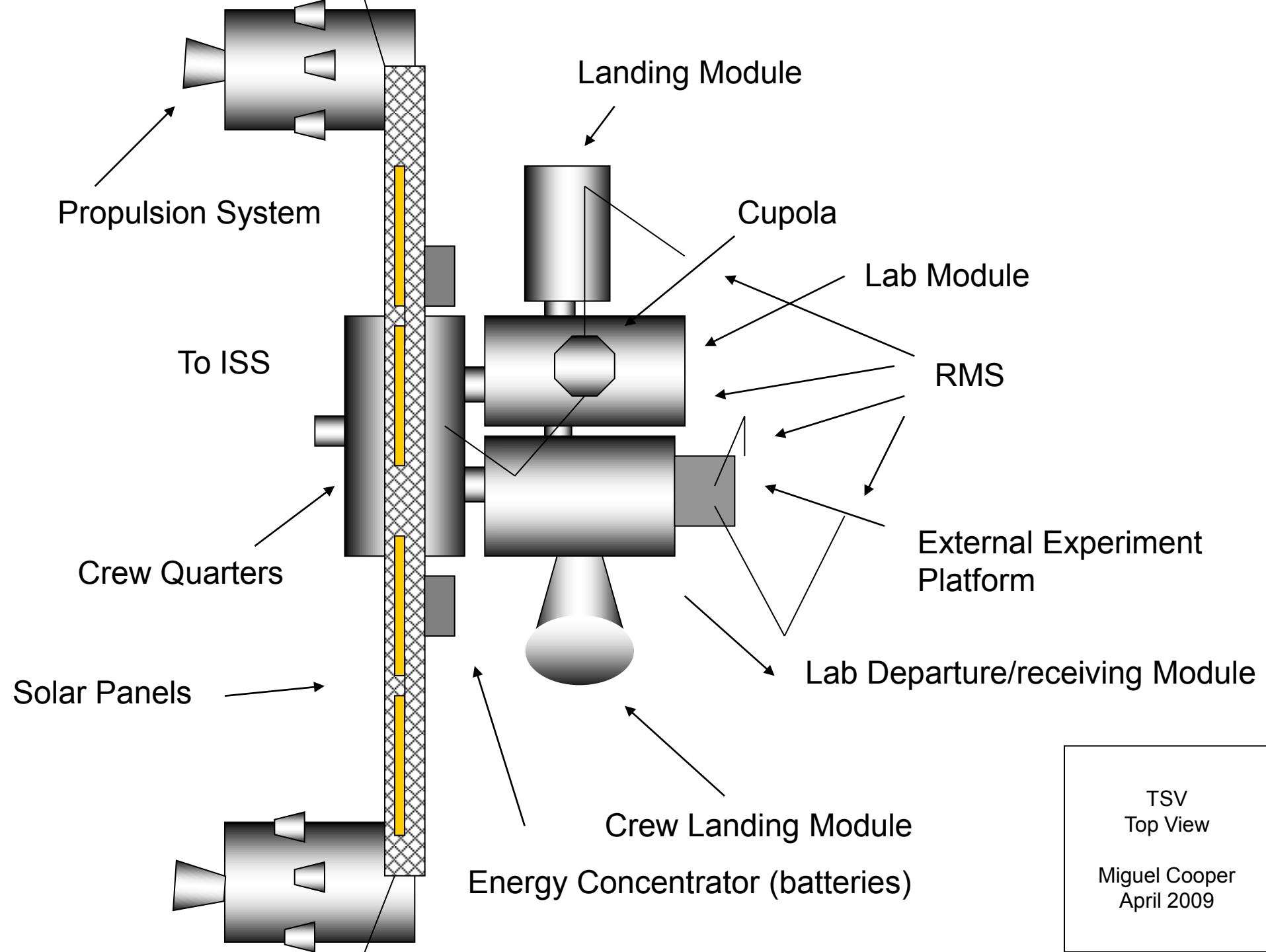

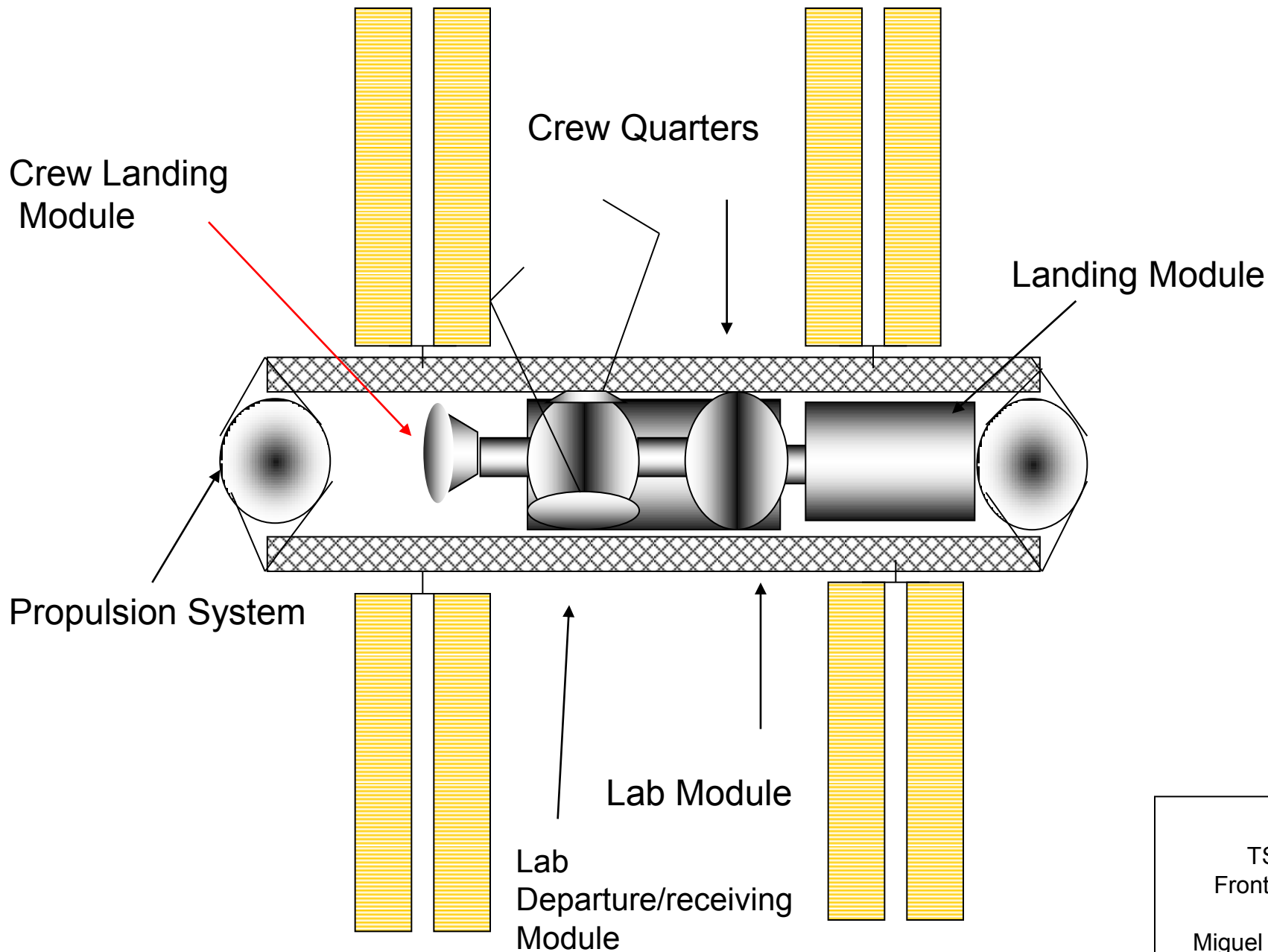

TSV
Front View

Miguel Cooper
April 2009

Lab
Departure/receiving
Module

Solar Panels

Propulsion System

Landing Module

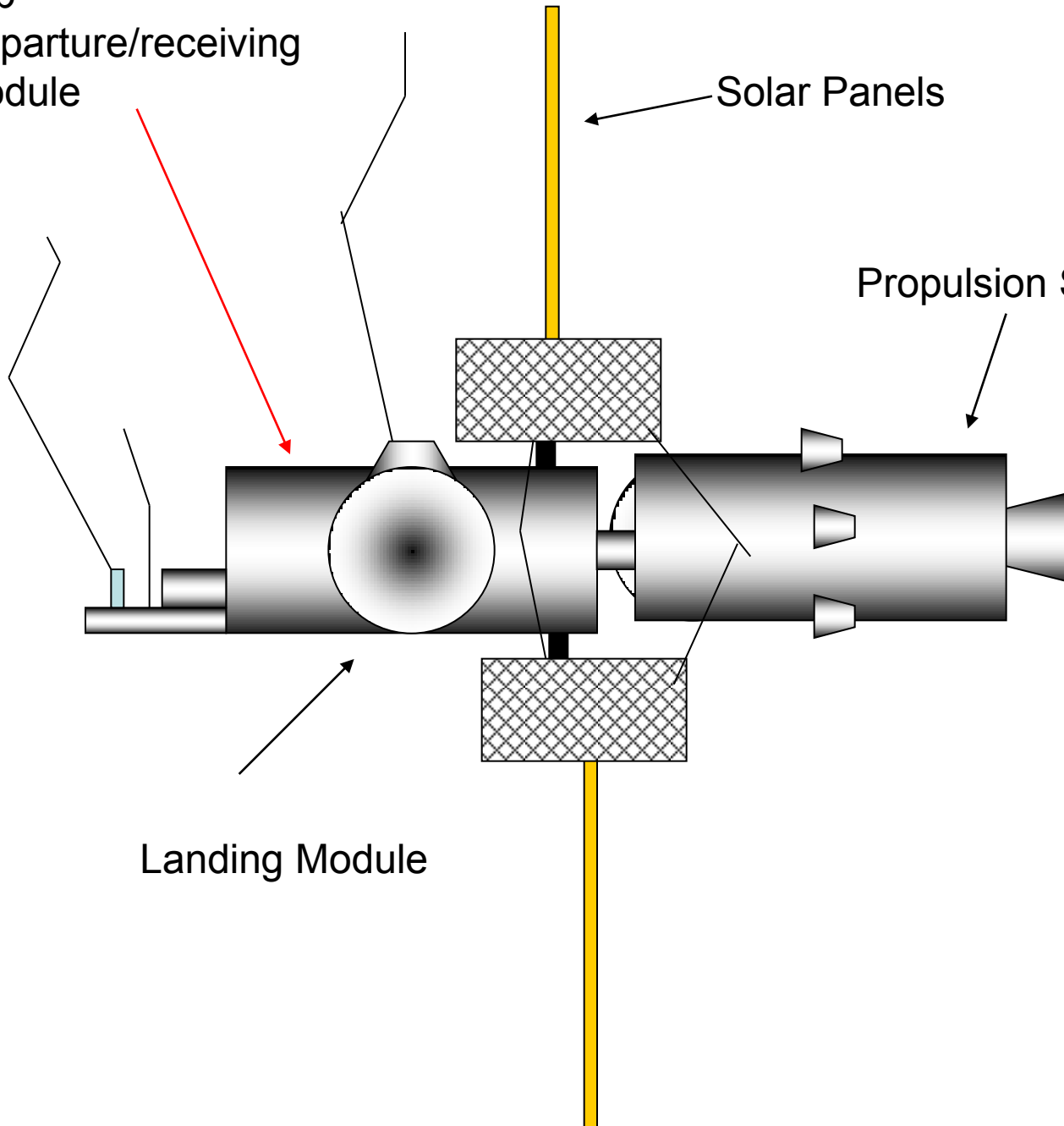

TSV
Lateral View

Miguel Cooper
April 2009

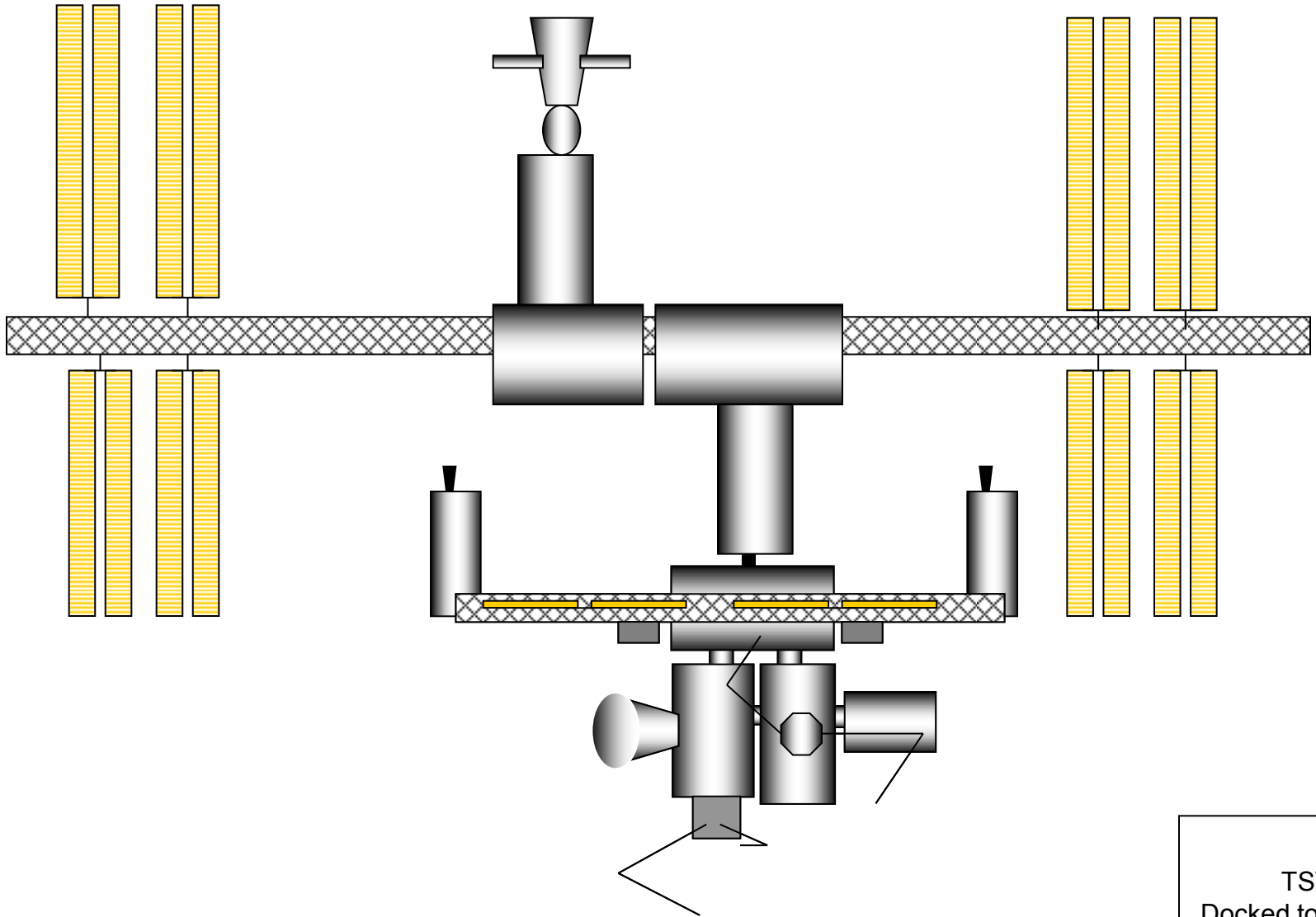

TSV
Docked to the ISS

Miguel Cooper
April 2009

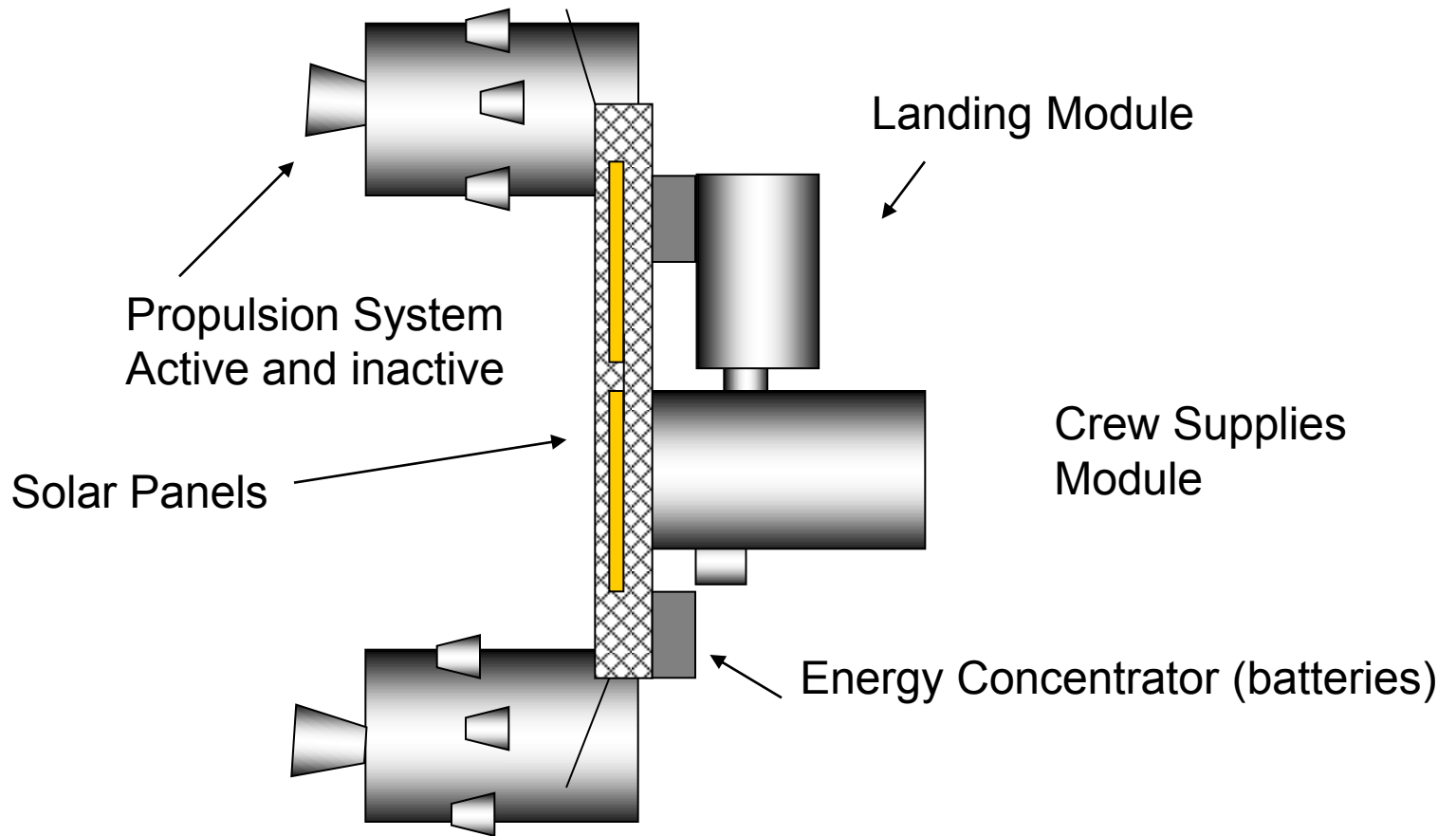

TSV
Unmanned
TSV

Miguel Cooper
April 2009

Deorbit Engines

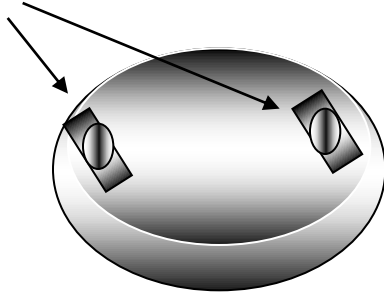

Environment Evaluation
Probe

Heat Shield

Parachute

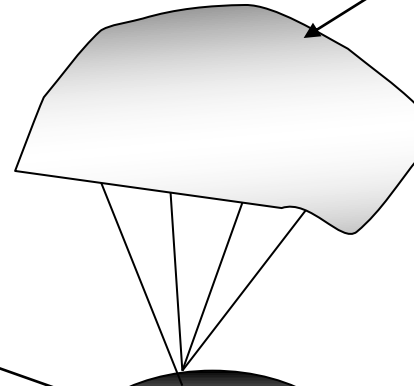

Antenna

Temperature

Wind Speed metering

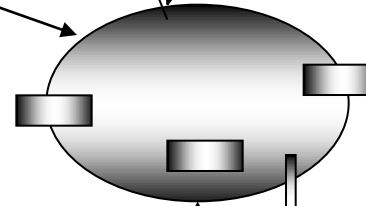

Descending speed

Particle density

TSV
Unmanned
environment
evaluation
Probe

Miguel Cooper
April 2009

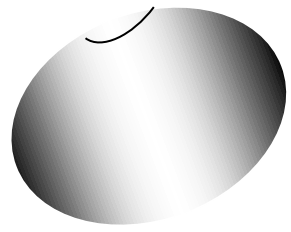

Atmospheric Entry

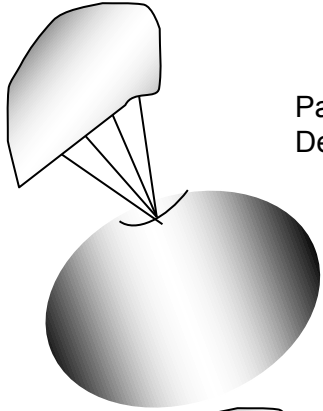

Parachute Deploy

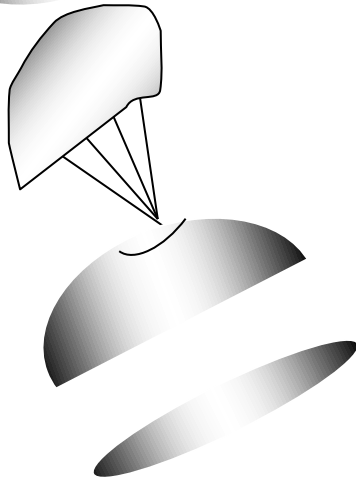

Heat Shield Separation

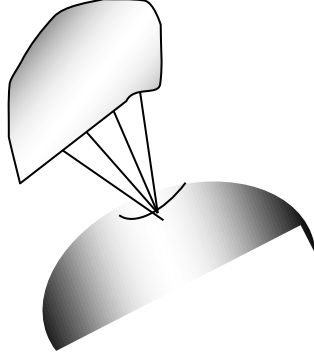

Heat Shield Separation (2)
Increase distance

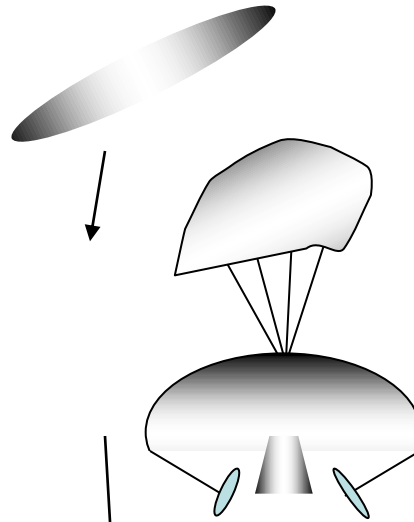

Container Separation
And container parachute
deploy

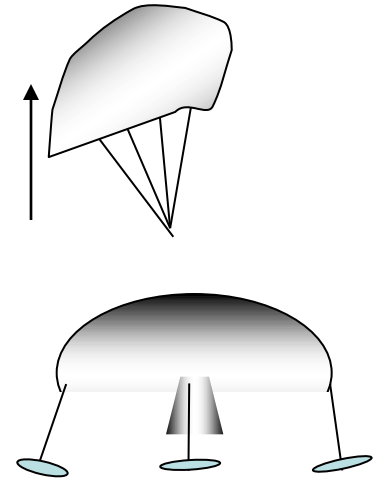

Parachute Separation
Landing Pads Extended

TSV
Crew supplies
container
Miguel Cooper
April 2009

Final Phase of landing

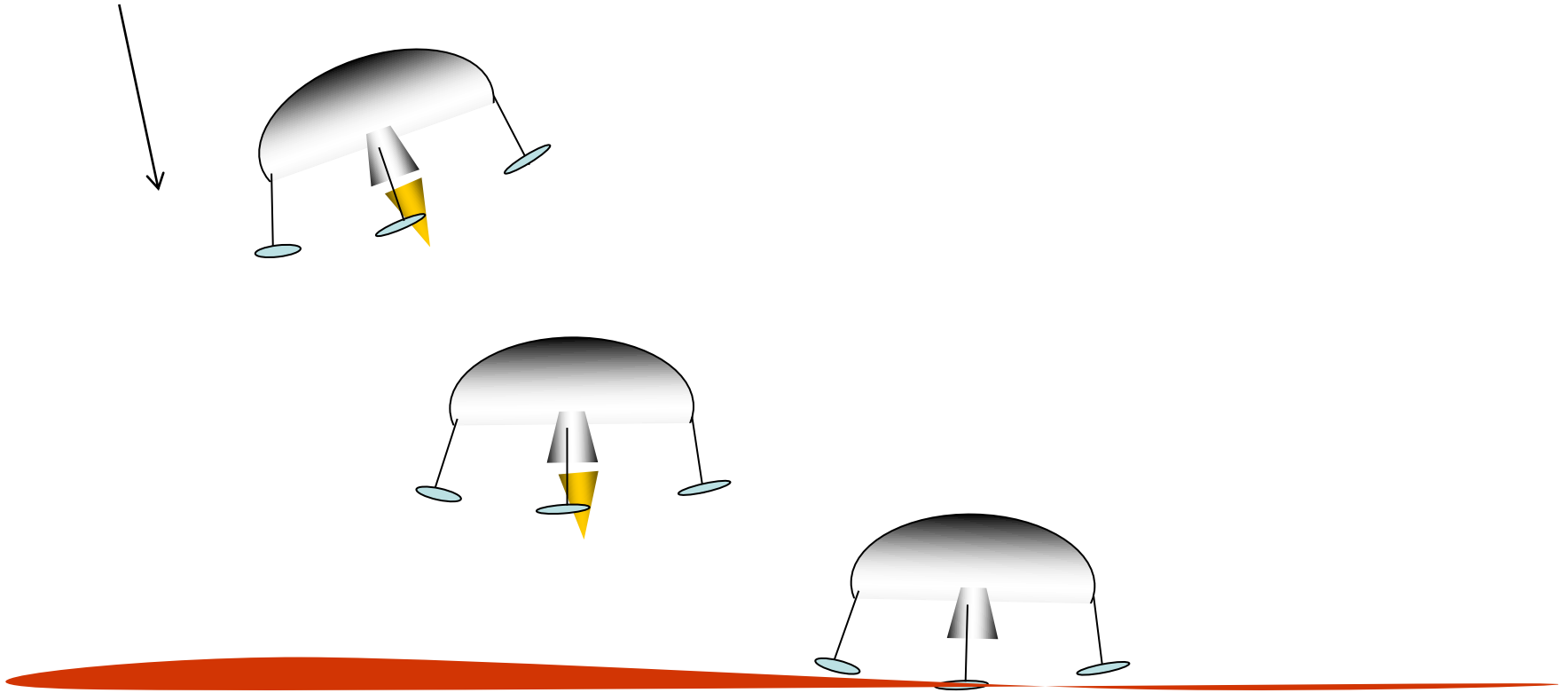

TSV
Crew supplies
container
Miguel Cooper
April 2009

Crew Supplies Container On the Surface

Once on the Surface the
Container extends its antenna
To be localized by the crew
And the hatch is opened to get
The Package of supplies.

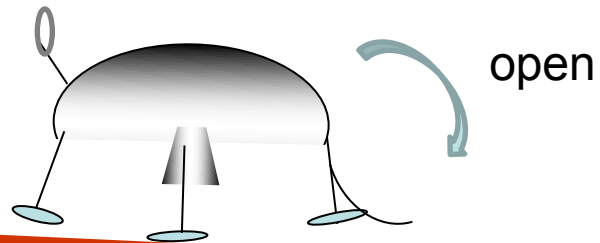

TSV
Crew supplies
container
Miguel Cooper
April 2009

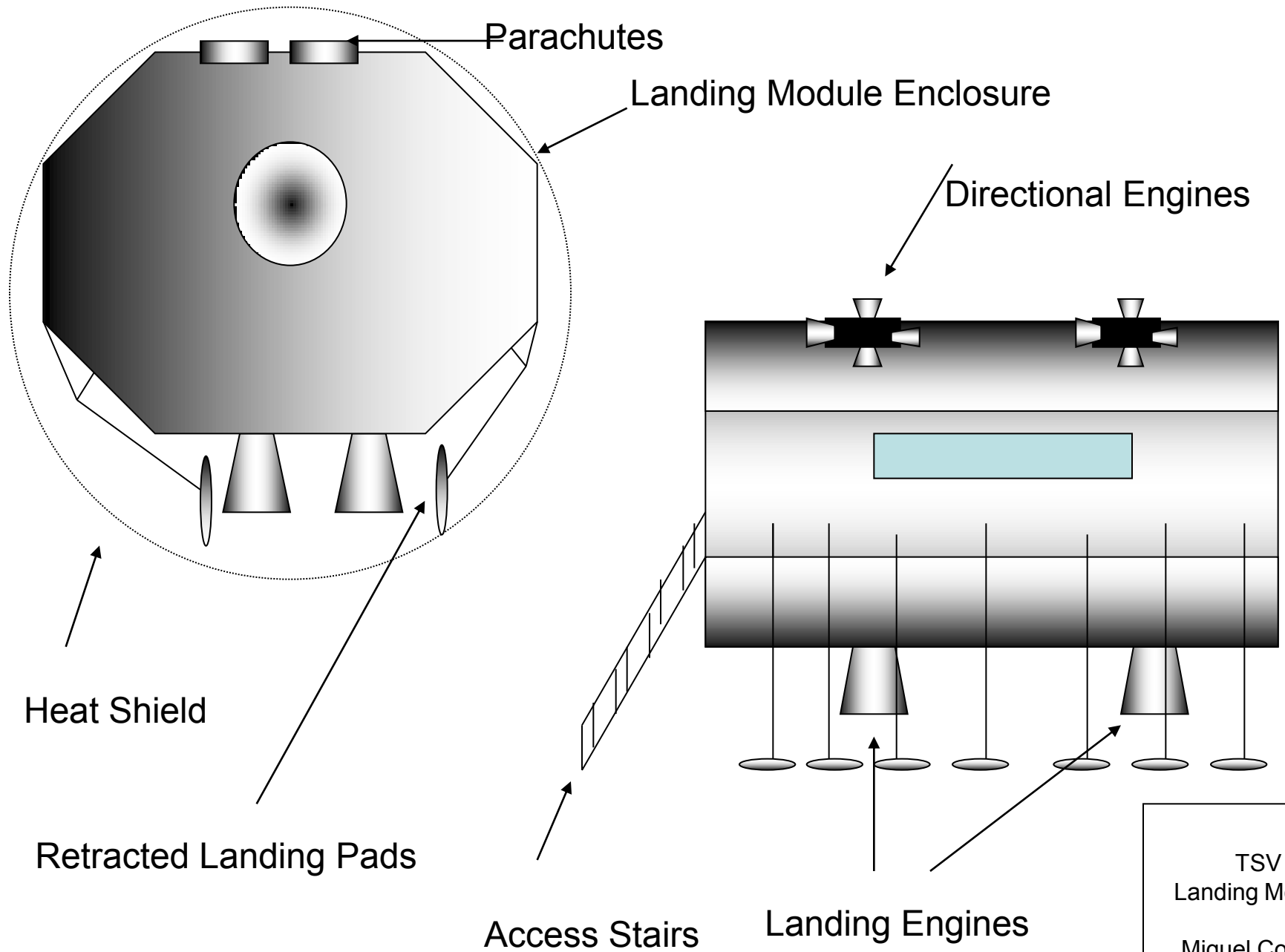

TSV
Landing Module

Miguel Cooper
April 2009

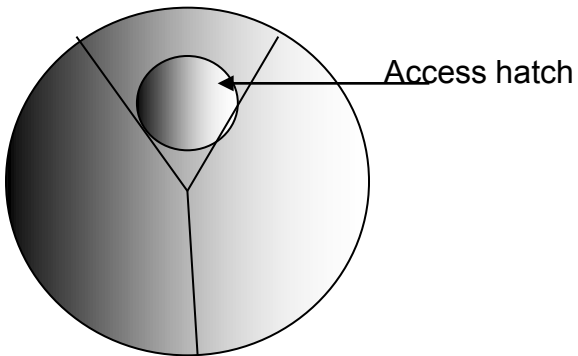

Front View

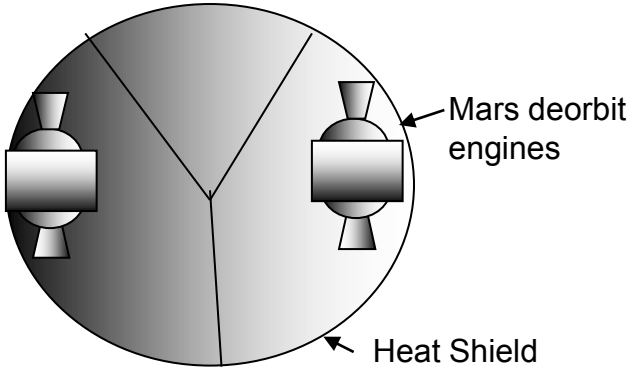

Back View

Landing Module Enclosure opening

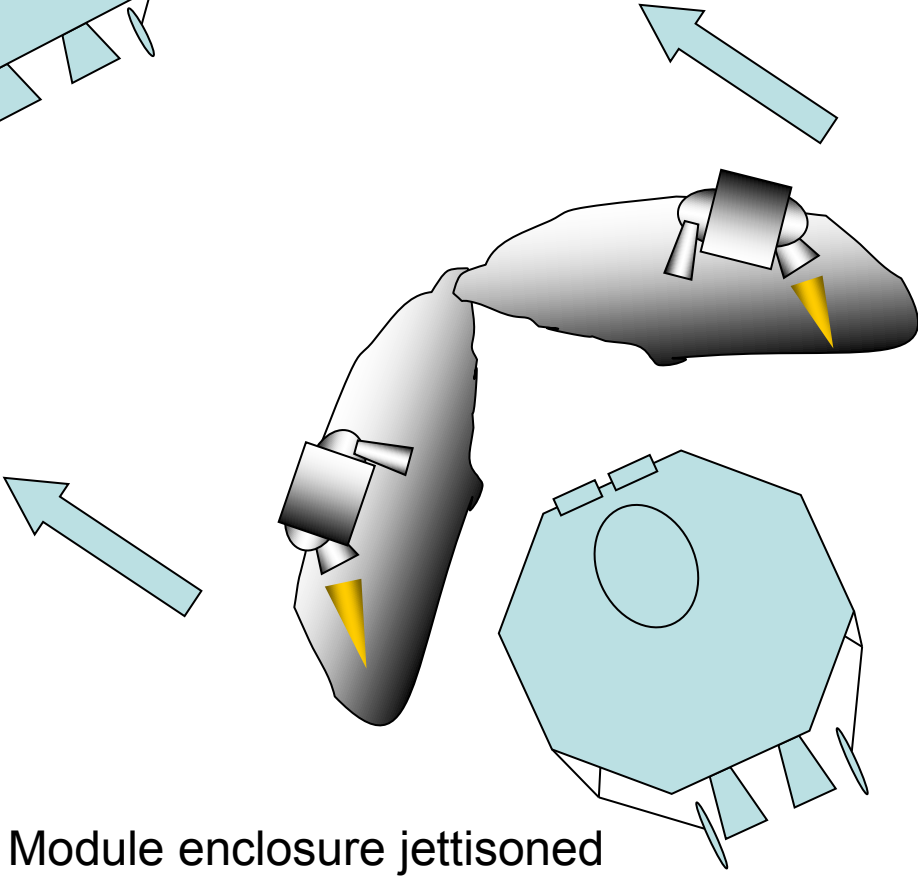
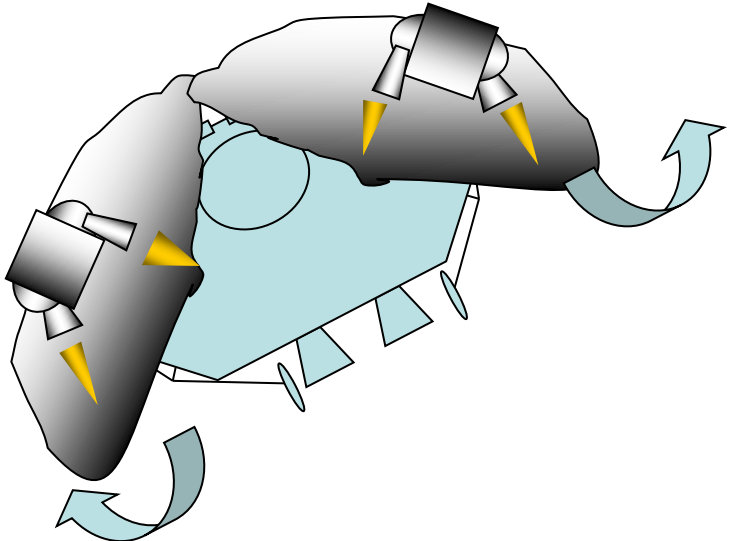

Landing Module enclosure jettisoned

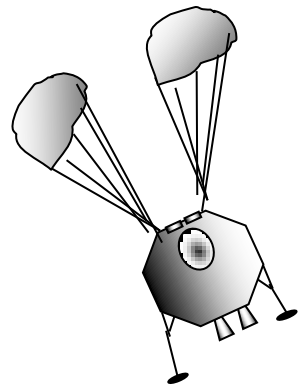

Parachute deploy

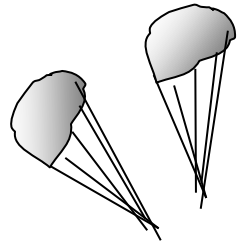

Parachute jettisoned
Landing engine start

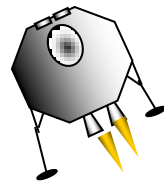

Descending corrections
With lateral engines

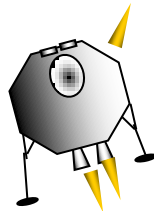

Engines Stop

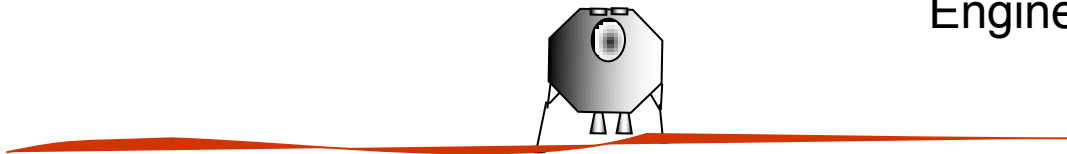

TSV
Landing Module
Landing Sequence

Miguel Cooper
April 2009

Landing Module

Wind mill

Solar Panels
(rotate)

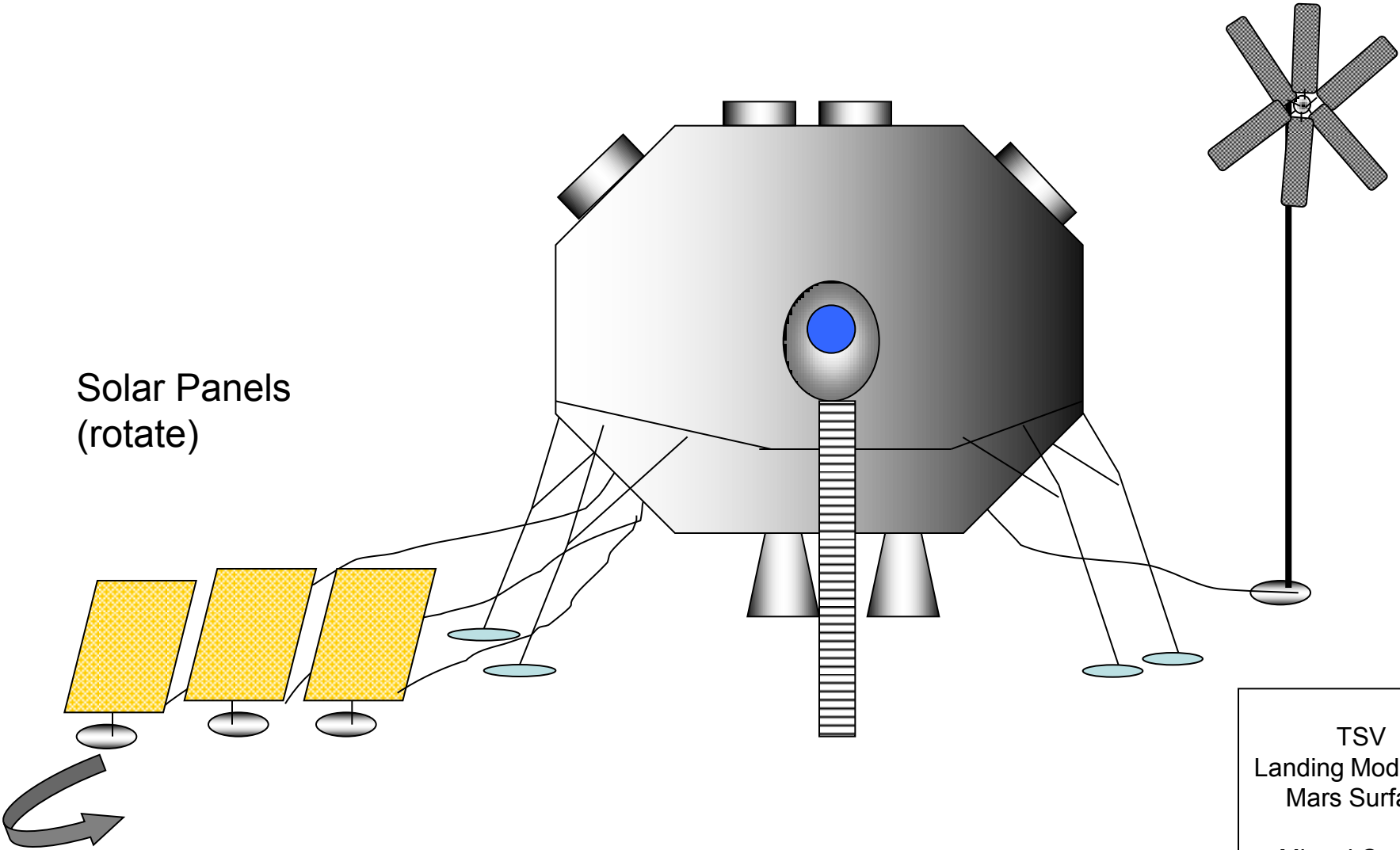

TSV
Landing Module on
Mars Surface

Miguel Cooper
April 2009

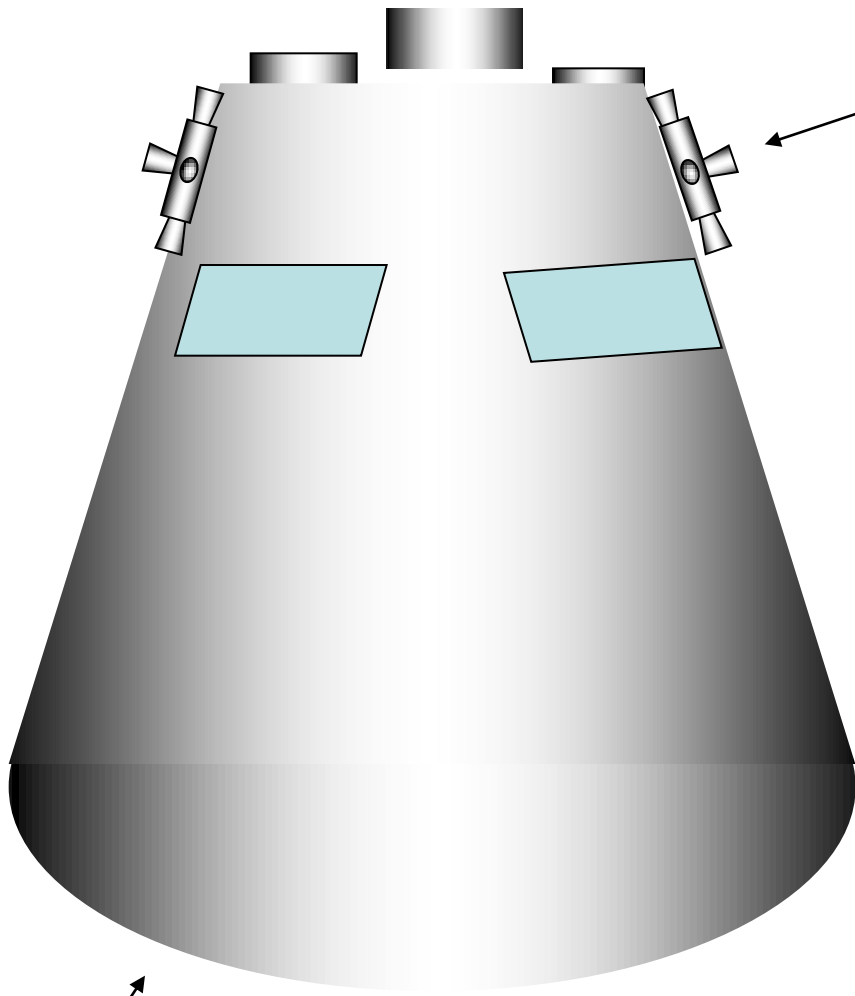

Landing Correction engines

Heat shield

TSV
Crew Landing
Module
With heat shield
Miguel Cooper
April 2009

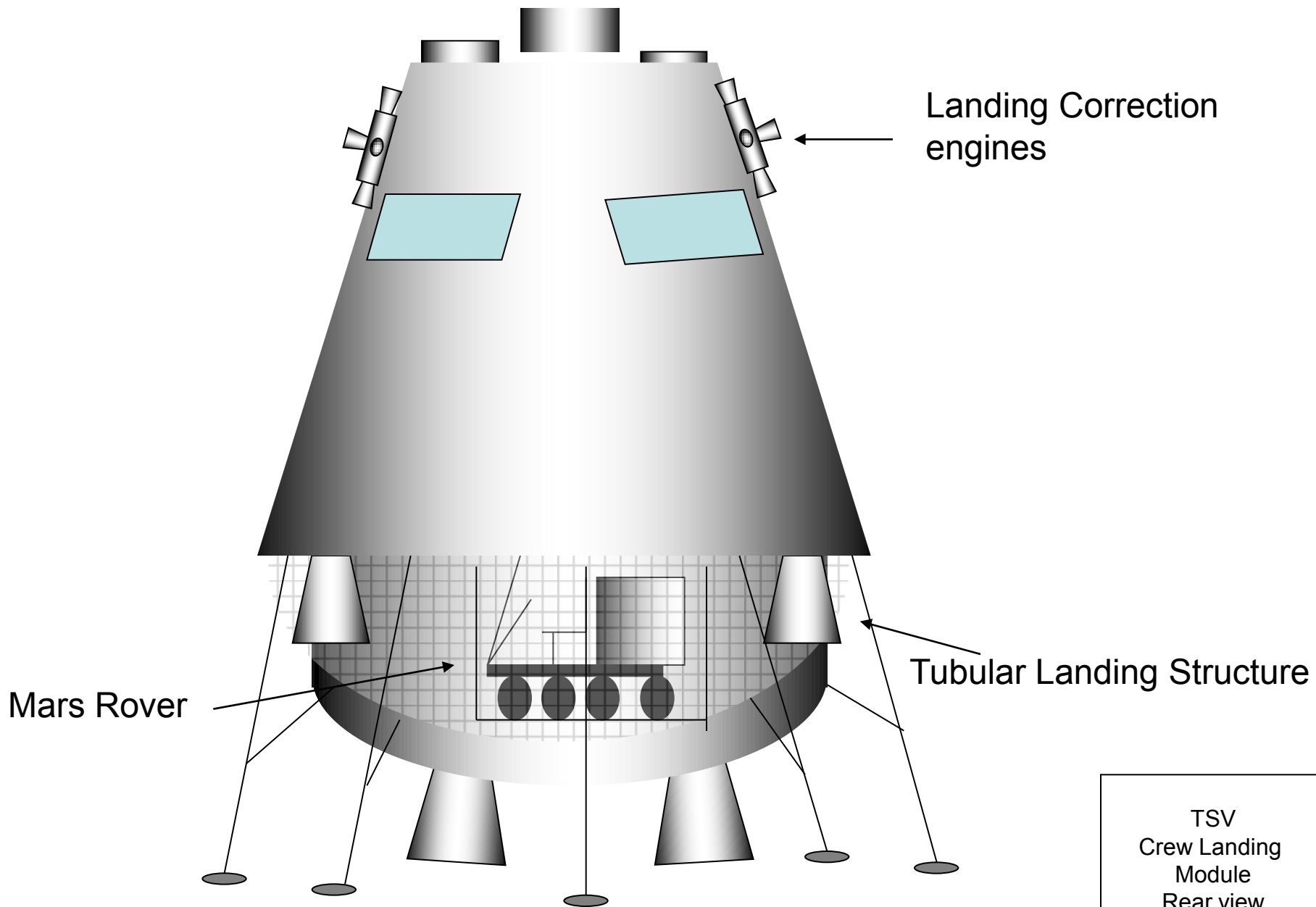

Landing Correction engines

Mars Rover

Tubular Landing Structure

TSV
Crew Landing
Module
Rear view
Miguel Cooper
April 2009

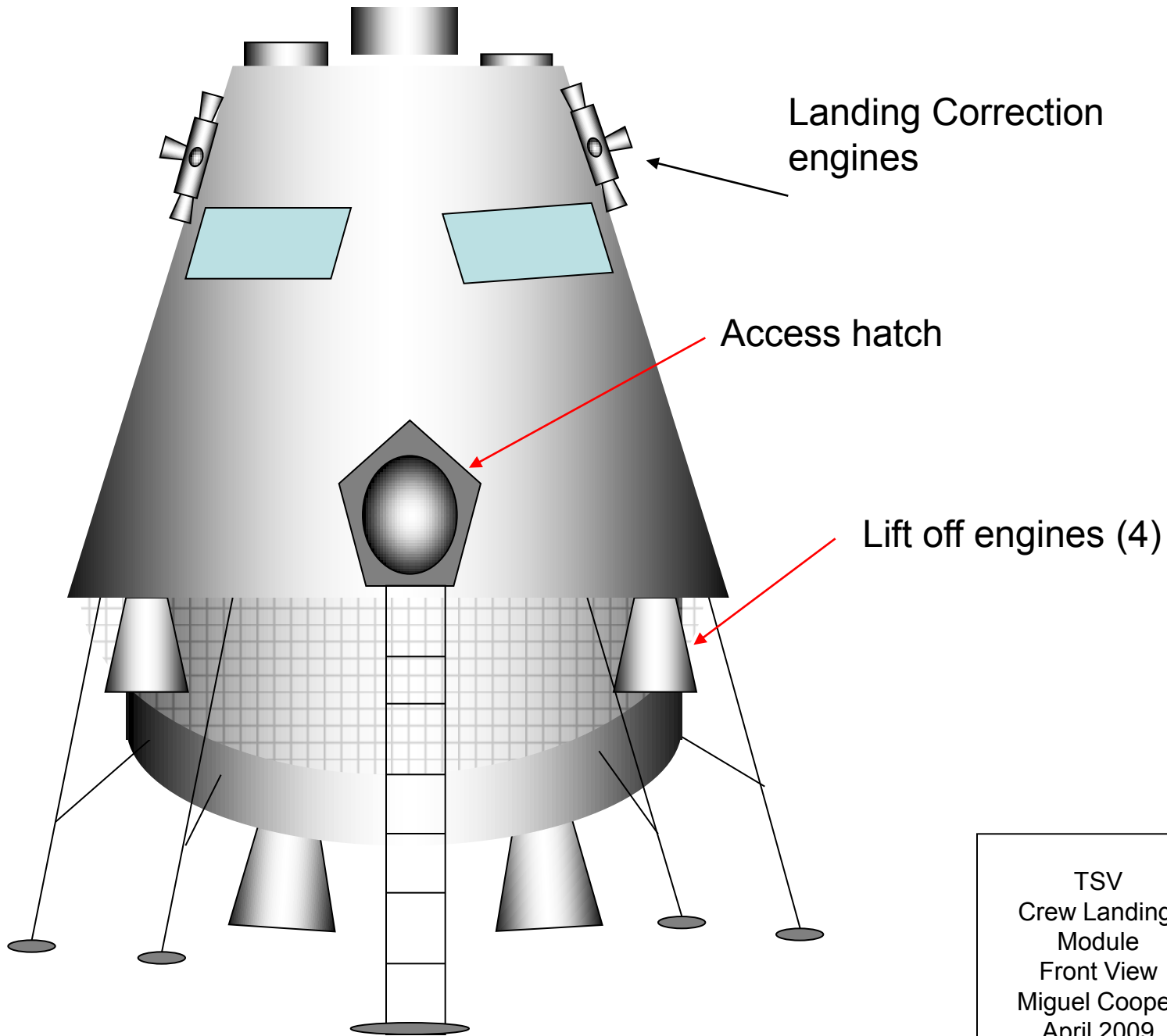

TSV
Crew Landing
Module
Front View
Miguel Cooper
April 2009

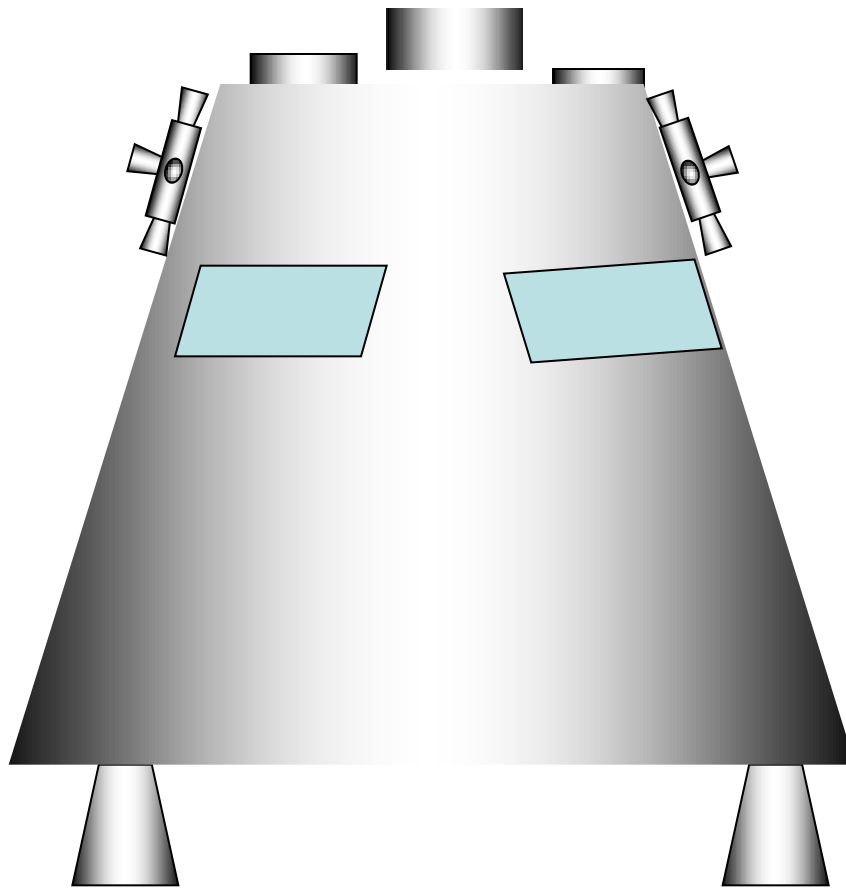

Lift off engines (4)

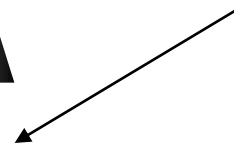

TSV
Crew Landing
Module
Ascent stage
Miguel Cooper
April 2009

Landing Module

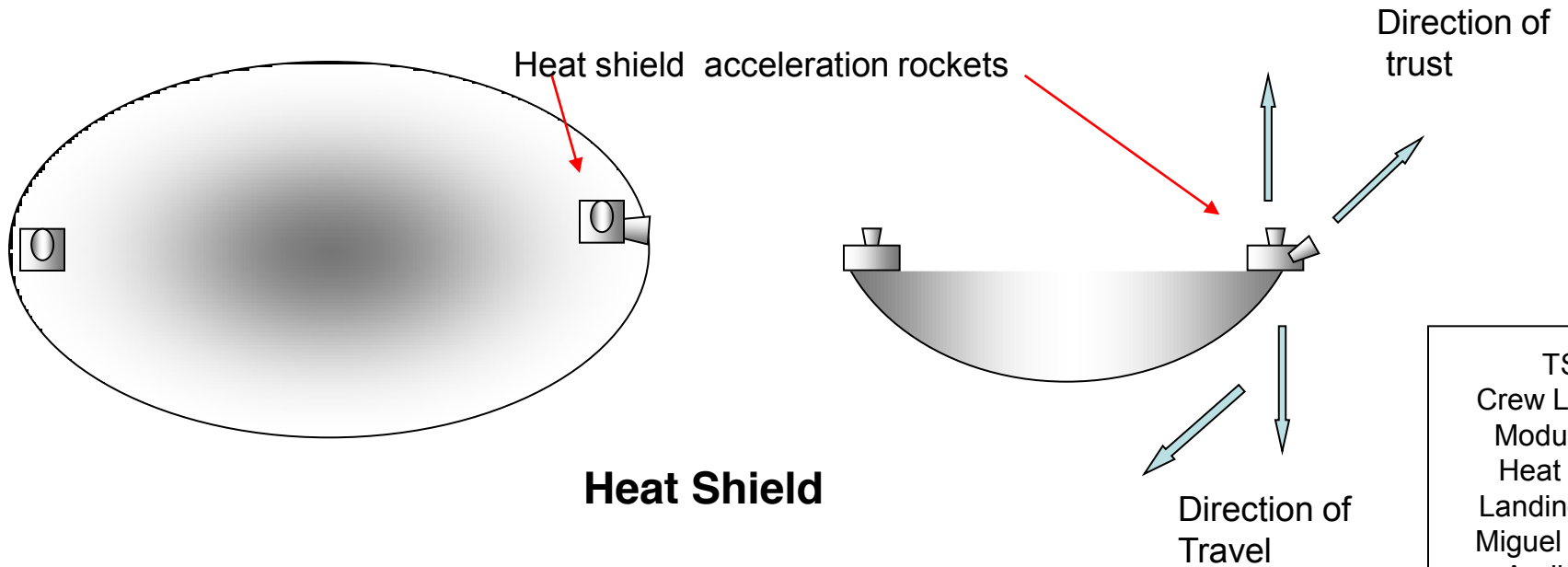
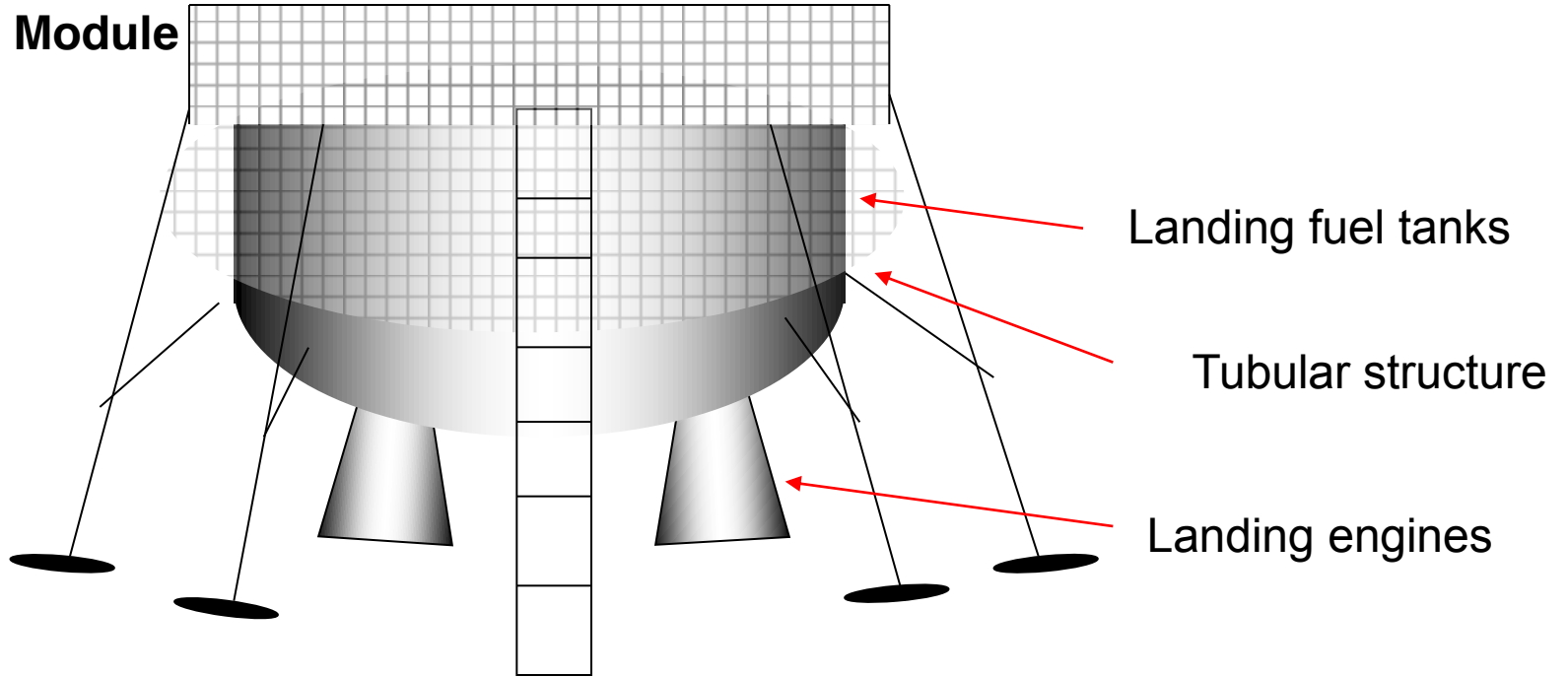

TSV
Crew Landing
Module and
Heat Shield
Landing stage
Miguel Cooper
April 2009

Mars Rover Compartment
And
Lowering mechanism

Tubular
Landing
Structure

Liftoff engines

Landing Engines

Landing Pads

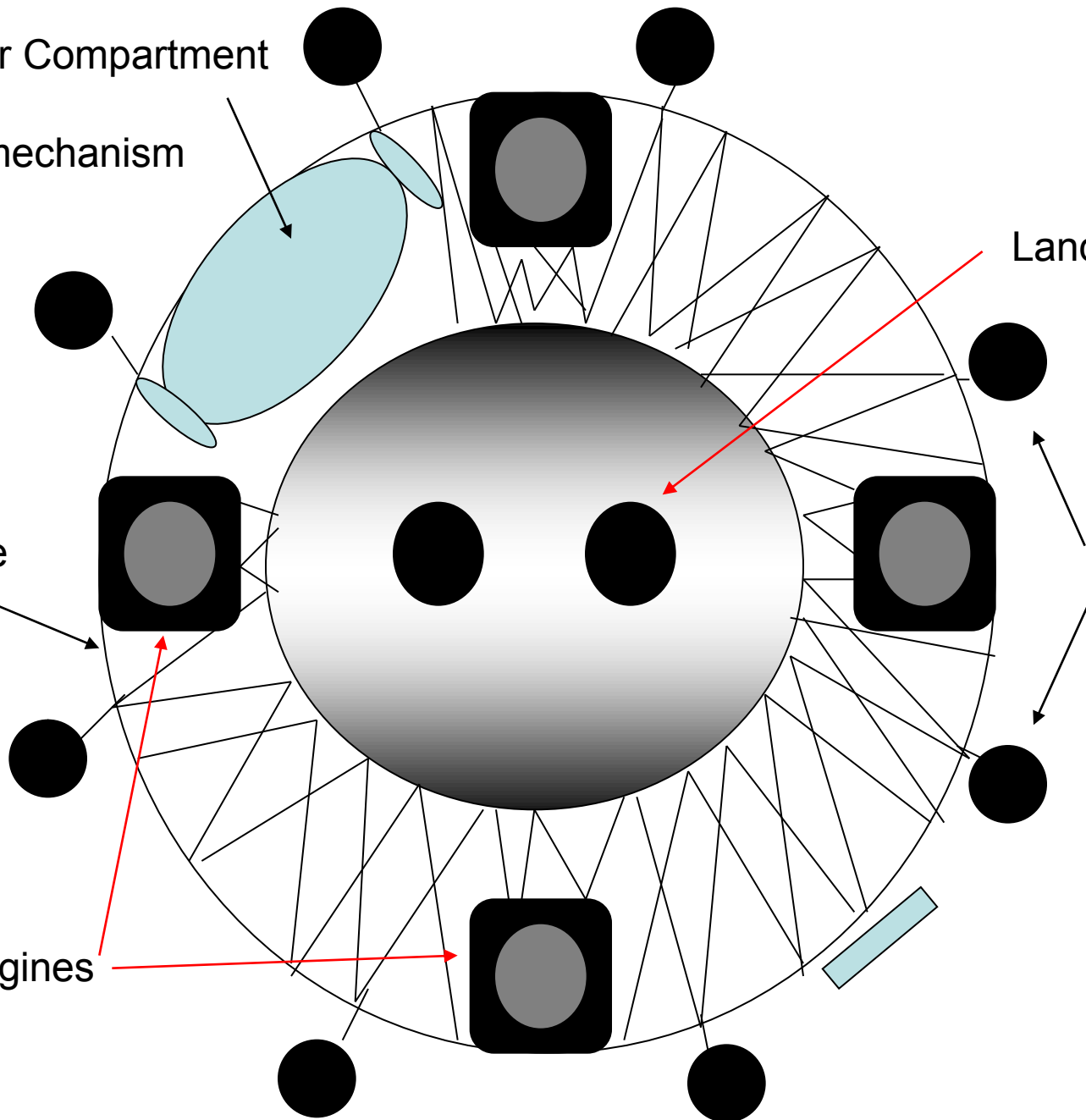

TSV
Crew Landing
Module
Landing stage
Bottom view
Miguel Cooper
April 2009

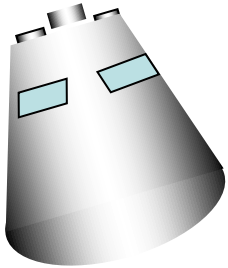

Atmosphere Entry

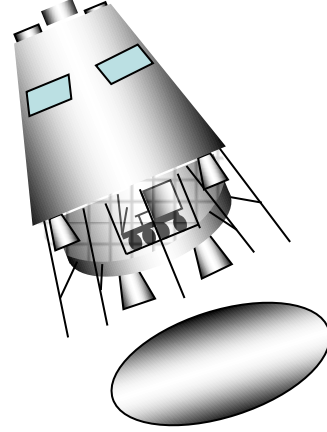

Heat Shield jettisoned

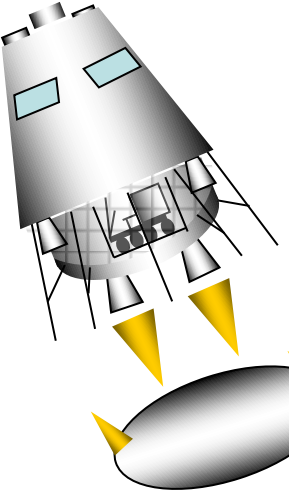

Landing Engines Start

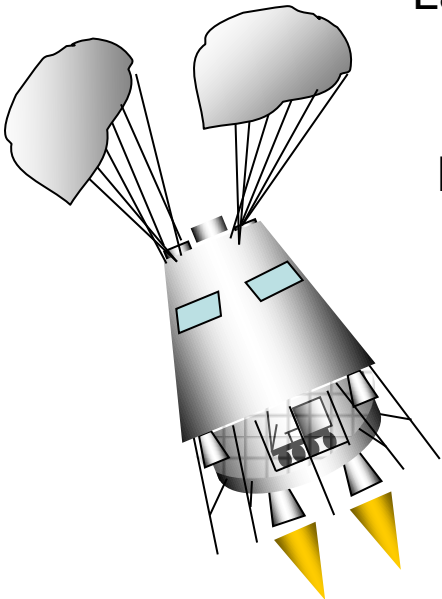

Parachutes deployment

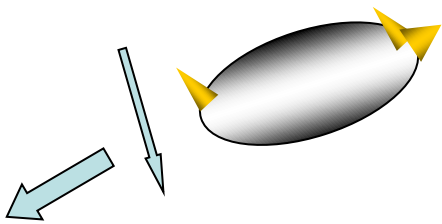

TSV
Crew Landing
Module
Landing Sequence
Miguel Cooper
April 2009

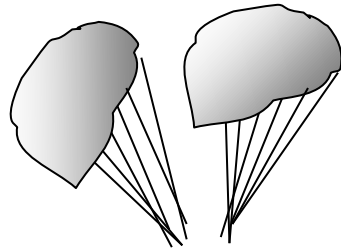
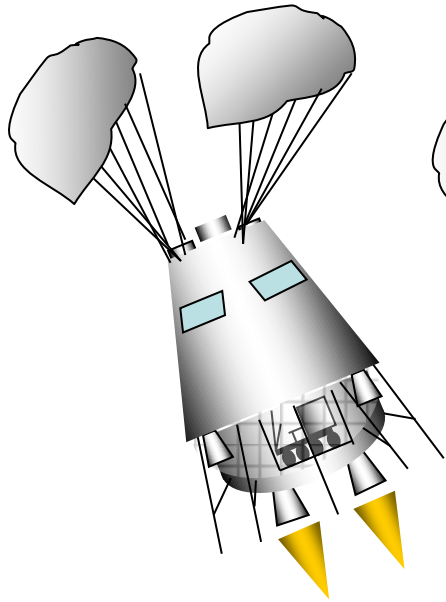

Parachutes jettisoned

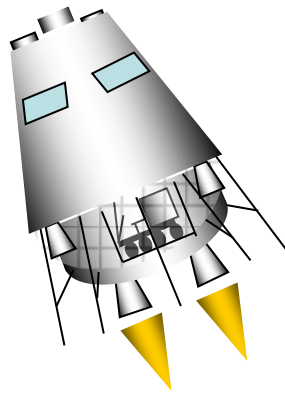

Course Correction

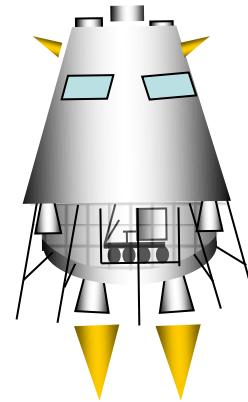

Mars Landing

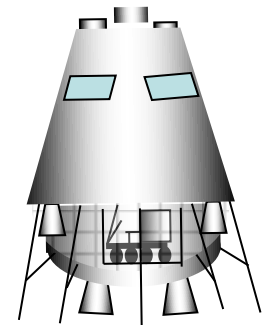

TSV
Crew Landing
Module,
landing module
and rover

Miguel Cooper
April 2009

